



Indusparquet

EXCELLENCE IN HARDWOOD FLOORING



ABOUT US

Some of the world's most respected settings, such as The Vatican, feature our products. Many of world's biggest and most upscale retail design leaders, like Louis Vuitton stores and Ferrari showrooms, trust their brand to our brand.

We manufacture, market, and sell premium Brazilian wood flooring with a focus on exceeding our customer's expectations through exceptional quality and craftsmanship. With over 50 years of experience, our company's foundation is built using the highest quality people, processes, and products in the industry.

It all started with a conversation in the 1970's between two young Brazilian cousins, Jose Antonio Baggio and Kiko Uliana. They dreamed of creating a sustainable business for their family that would share the beautiful natural resources of their home country with the world. As 19 year old workers for the family sawmill, they learned early that efficient manufacturing processes and responsible forestation could not be compromised in order to protect their beloved countryside. Four generations later, these same core values are the driving force of Indusparquet and has become the legacy of our Founders.

We know that we would not exist without our customers. We carefully select the highest quality raw materials and produce products that appeal to those who have an eye for design. Leading architects and designers choose our wood flooring for the beauty and durability, and remain clients because of our unique and evolving product selection and commitment to excellence.



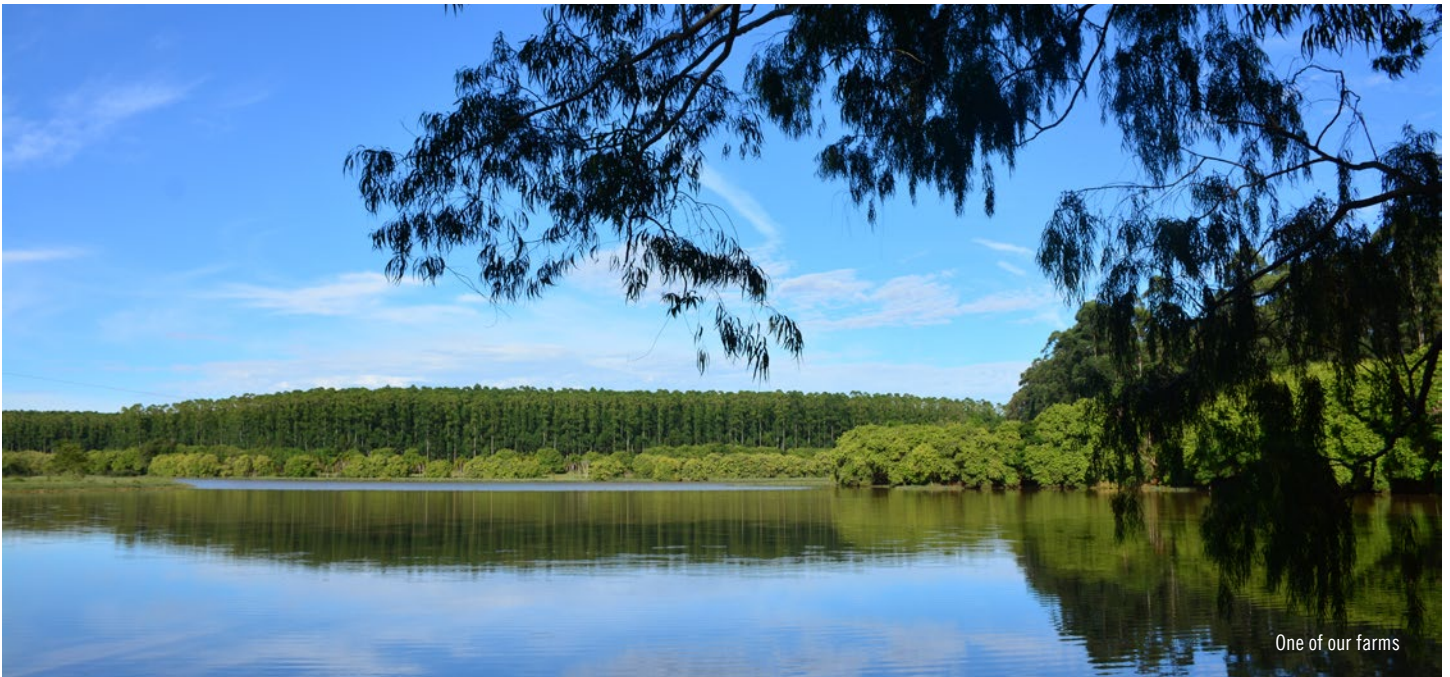

One of our farms

ENVIRONMENT

Beyond the beauty of Indusparquet’s hardwoods, clients trust that our products preserve and protect the environment. We work closely with the Brazilian government, which strictly controls the country’s timber harvest.

The guidelines of IBAMA (Instituto Brasileiro do Meio Ambiente e dos Recursos Naturais Renováveis) demands lumber to be sourced from reforestation, or managed forests. Only eight trees per ¾ acre can be removed from the forest. So, as part of our pledge, and to be compliant, we don’t remove endangered trees, trees that provide food for animals and trees that are seed carriers. Because few trees are removed and the fertile ones remain, the forest naturally regenerates itself.

Growth of smaller trees is nurtured when we remove the mature trees, naturally. Every tree harvested is tagged with an ID code

We pledge to be forest-friendly as well. That means craftsmanship, care, and the long view on what is best for our world always impact our decisions.

that is controlled by GPS technology, and stays with the tree throughout the manufacturing process.

Our careful planning goes from the extraction of the logs through reforestation areas. Our process includes a goal that consumes 100% of all timber that arrives at the factory. By-products are used to create innovative-design oriented recycled products, or to generate energy for the factories in the boiler. It takes more planning and a little more thought, but our reputation is based on a goal of zero waste.

Indusparquet has the certification chain of custody FSC (Forest Stewardship Council), which is the highest standard in our country and means we provide products that are made with timber from managed forests, according to strict social and environmental criteria.

Certifications





TECHNOLOGY

Just because we're over 50 years old, doesn't mean we don't have the latest technology. Our manufacturing is as beautiful as our wood.

The world's best architectural and design firms trust us with their biggest and most important projects because of our engineering expertise. Our 500-plus employees, many third-generation artisans, export products to over 30 countries because the world has discovered our quality and beauty.

We use an innovative lumber drying process that includes seventeen on-site kilns to add stabilization and eliminate insects and fungus. The wood is subjected to extreme temperatures and lumber conditioning for 10 days before moving into flooring production.

In order to mill our product to perfection, we utilize state of the art machinery and computer aided quality control measures supported by our hardwood professionals throughout the manufacturing process. Our technical knowledge and experience – from the forest through the lab – are constantly improving to ensure we meet the highest quality expectations, in which we have built a worldwide reputation.

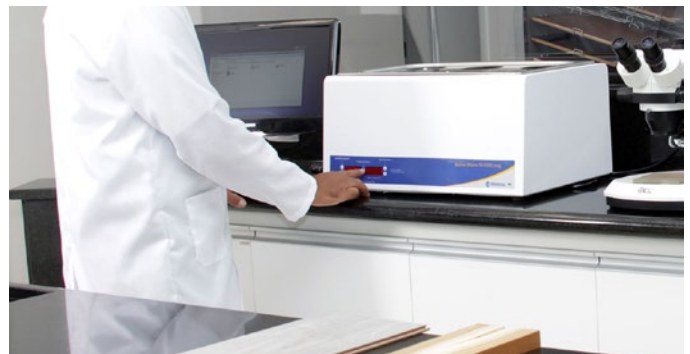

THE INDUSPARQUET DIFFERENCE



A colorless, nine-coat applied crystal clear finish allows our exceptional rich colors and textures to come through within each of our exotic hardwood profiles. Due to this exclusive process, our floors need minimal maintenance and do not require waxing.



An exclusive, natural drying process which the lumber is left to breathe and de-moisturize in a fresh air environment for no less than six months for a more durable, dimensionally stable finished product.



Long Length products are milled and randomly cut longer than the standard 48" of most imports. These longer lengths provide the ultimate in linear elegance with a mix that delivers superlative visual balance and beauty.



High performance aluminium-oxide crystals deliver unprecedented scratch and abrasion resistance. Our products are designed to meet the extra demands of commercial work spaces.

PROFILE INFORMATION

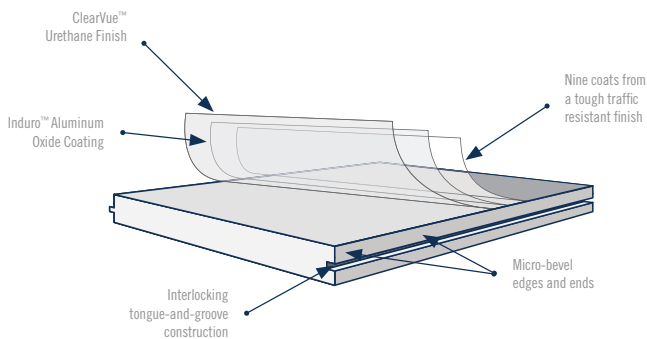

SOLID PROFILES

Our hardwoods come in a range of thicknesses and lengths and can be sanded and refinished multiple times, because it's solid from top to bottom. Available in an extensive range of hardwood species, with the option of having unique, handcrafted, textured finishes or Induro™ aluminum oxide coating and nine layers of ClearVue™ varnish, the solid profile, like nature itself, will never fail you.

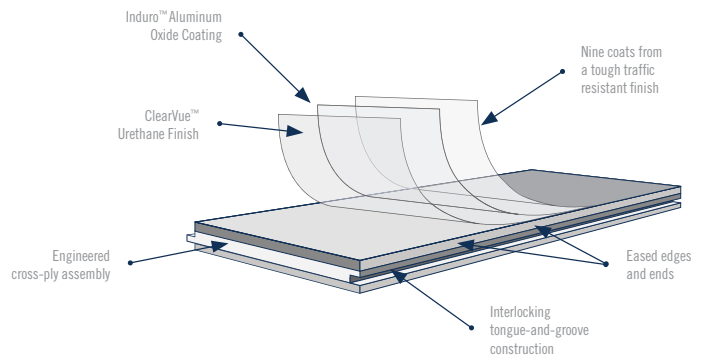

ENGINEERED PROFILES

Our products are built to be as durable as they are beautiful. All engineered profiles are a multi-ply construction using 100% hardwood. Every sub ply has different grain direction to improve stability. This structure reduces the expansion and contraction of the wood. We know that improves performance, especially in environments with high fluctuation in humidity and temperature. Engineered flooring can be installed below, on, or above grade.





SOLIDO COLLECTION

3/4" SOLID HARDWOOD

Tigerwood

Our “Solido” Hardwood Collection offers a mixture of various Brazilian hardwood species with options appealing to both the traditionalist and those with a modern contemporary flare. The smooth grouping of products in this line provide timeless appeal with warm natural tones. Our textured lower-gloss formats create a more modern spin using the same hardwood species indigenous to our home country, Brazil. Regardless of your preference, these solid hardwood products are sure to impress!

DURABILITY (HARDNESS RATING)

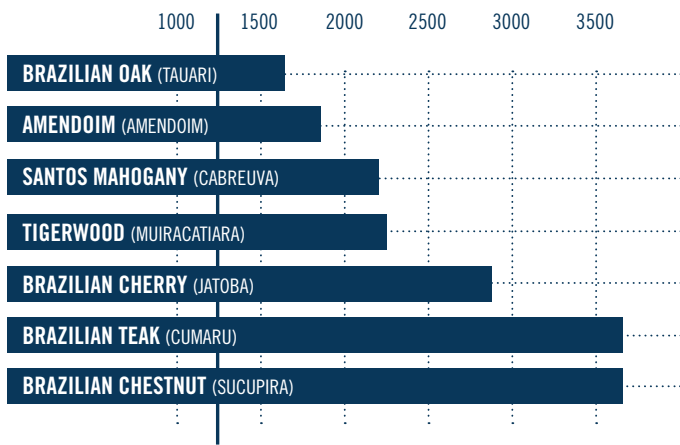

RED OAK 1290 RATING (Most Indusparquet species are harder than domestics.)

KEY FEATURES

- 7 BRAZILIAN SPECIES
- SOLID HARDWOOD
- SMOOTH AND TEXTURED OPTIONS AVAILABLE
- VARIOUS WIDTHS AVAILABLE
- LONG BOARD LENGTHS
- HARDER THAN DOMESTIC

PRODUCT INFORMATION

Thickness	3/4" SOLID
Width	3", 4" & 5 1/2"
Length	RANDOM LENGTH 11" - 84"
Gloss Options	MEDIUM & LOW
Installation	NAIL ONLY
Areas	ON, ABOVE GRADE
Edge Profile	MICRO BEVEL
Packing	3" – 21.1 SF PER CARTON 4" – 18.73 SF PER CARTON 5-1/2" – 19.37 SF PER CARTON
Warranties	25 YEARS RESIDENTIAL AND 5 YEARS COMMERCIAL

Solido Collection

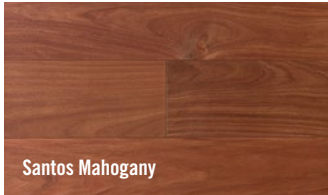

Santos Mahogany

SPECIES	CABREUVA
LIGHT SENSITIVITY	LOW
SM3431000	3/4" x 3"
SM3451000	3/4" x 5 1/2"



Brazilian Teak

SPECIES	CUMARU
LIGHT SENSITIVITY	LOW
BT3431000	3/4" x 3"

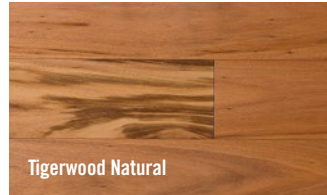

Tigerwood Natural

SPECIES	MUIRACATIARA
LIGHT SENSITIVITY	HIGH
TW3431000	3/4" x 3"
TW3451000	3/4" x 5 1/2"

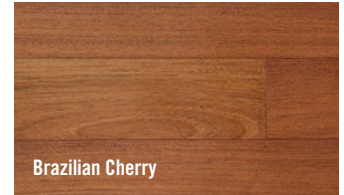

Brazilian Cherry

SPECIES	JATOBA
LIGHT SENSITIVITY	HIGH
BC3431000	3/4" x 3"
BC3441000	3/4" x 4"
BC3451000	3/4" x 5 1/2"



Amendoim

SPECIES	AMENDOIM
LIGHT SENSITIVITY	MEDIUM
AME3431000	3/4" x 3"
AME3441000	3/4" x 4"
AME3451000	3/4" x 5 1/2"

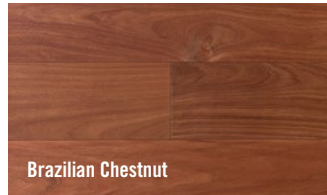

Brazilian Chestnut

SPECIES	SUCUPIRA
LIGHT SENSITIVITY	LOW
BCH3431000	3/4" x 3"
BCH3451000	3/4" x 5 1/2"

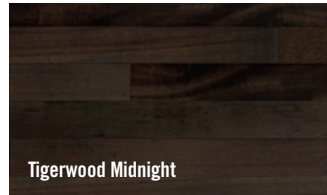

Tigerwood Midnight

SPECIES	MUIRACATIARA
LIGHT SENSITIVITY	HIGH
TW3452111	3/4" x 5 1/2"

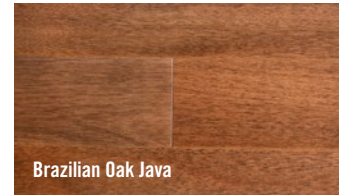

Brazilian Oak Java

SPECIES	TAUARI
LIGHT SENSITIVITY	LOW
B03453666	3/4" x 5 1/2"

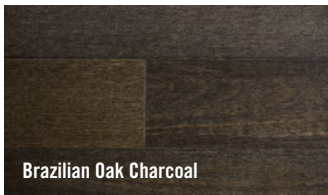

Brazilian Oak Charcoal

SPECIES	TAUARI
LIGHT SENSITIVITY	LOW
B03453333	3/4" x 5 1/2"



Brazilian Oak Mystic White

SPECIES	TAUARI
LIGHT SENSITIVITY	MEDIUM
B03453888	3/4" x 5 1/2"

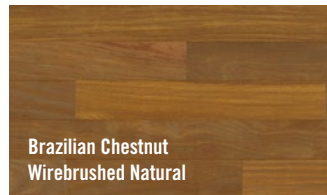

Brazilian Chestnut Wirebrushed Natural

SPECIES	SUCUPIRA
LIGHT SENSITIVITY	LOW
BCH344WB1000	3/4" x 4"

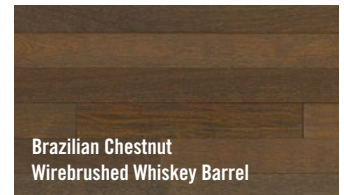

Brazilian Chestnut Wirebrushed Whiskey Barrel

SPECIES	SUCUPIRA
LIGHT SENSITIVITY	LOW
BCH343WB1555	3/4" x 3"

Product Gallery



Amendoim



Brazilian Oak Mystic White



Brazilian Chestnut



CLASSICO COLLECTION

1/2" SMOOTH ENGINEERED HARDWOOD

Brazilian Cherry

Our "Classico" Collection is a traditional favorite for discriminating homeowners across the globe. Our engineered collection boasts some of the top selling species. Offered by Indusparquet, highlighted by visuals with classic, enduring beauty and extraordinary lines. The beauty of these products are enhanced by a classic 3MM dry sawn face, precision sanded for a modern, sleek look, and featuring our patented Breathe™ natural wood drying process. We want to give homeowners products that are built just as good as how they look on your floor. From the exuberant personality of Brazilian Pecan to our warm traditional tones found in our Amendoim, these selections are custom made for any décor.

DURABILITY (HARDNESS RATING)

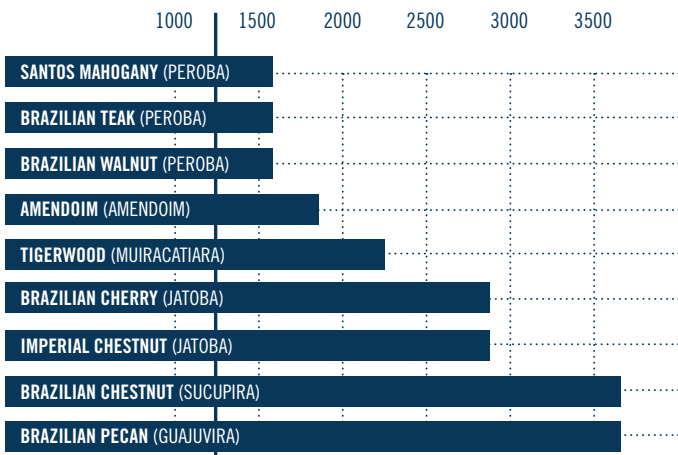

RED OAK 1290 RATING (Most Indusparquet species are harder than domestics.)

KEY FEATURES

- 9 BRAZILIAN SPECIES
- 1/2" X 5" ENGINEERED HARDWOOD
- 3MM SAWN FACE VENEER
- CLASSIC SMOOTH TEXTURE
- LONG BOARD LENGTHS
- HARDER THAN DOMESTIC
- TOP SELLING COLLECTION

PRODUCT INFORMATION

Thickness	1/2" ENGINEERED
Width	5" ONLY
Length	11" - 84" (MOST); 11" - 48" (AMENDOIM & BRAZ PECAN)
Gloss Options	MEDIUM
Installation	STAPLE, GLUE, FLOAT
Areas	ON, ABOVE & BELOW GRADE
Edge Profile	MICRO BEVEL
Packing	30.03 SF PER CARTON
Warranties	25 YEARS RESIDENTIAL AND 5 YEARS COMMERCIAL

Classico Collection

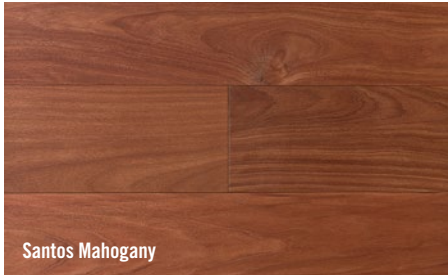

Santos Mahogany

SPECIES PEROBA
 LIGHT SENSITIVITY LOW
 SM12100 1/2" x 5"



Brazilian Teak

SPECIES PEROBA
 LIGHT SENSITIVITY LOW
 BT12100 1/2" x 5"

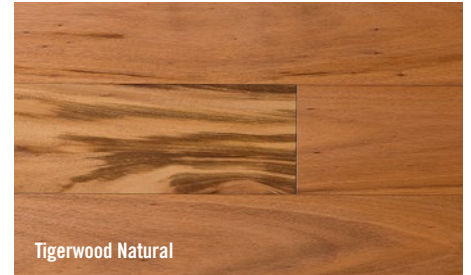

Tigerwood Natural

SPECIES MUIRACATIARA
 LIGHT SENSITIVITY HIGH
 TW12100 1/2" x 5"

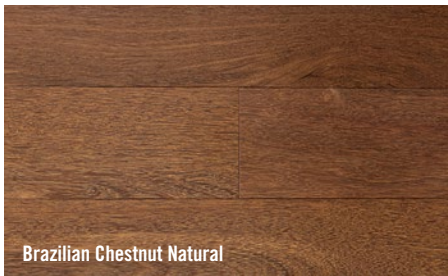

Brazilian Chestnut Natural

SPECIES SUCUPIRA
 LIGHT SENSITIVITY MEDIUM
 BCH12100 1/2" x 5"

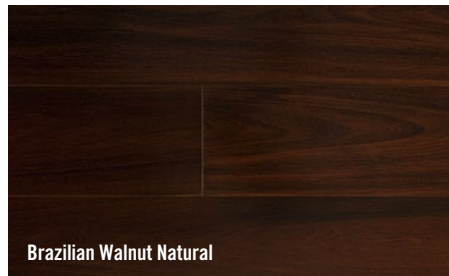

Brazilian Walnut Natural

SPECIES PEROBA
 LIGHT SENSITIVITY LOW
 BW12100 1/2" x 5"

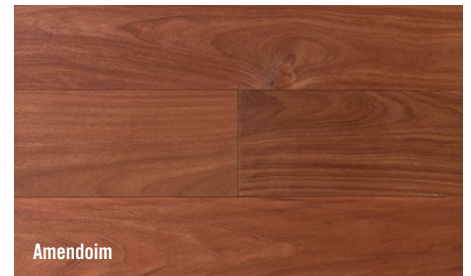

Amendoim

SPECIES AMENDOIM
 LIGHT SENSITIVITY MEDIUM
 AME12100 1/2" x 5"



Brazilian Pecan Natural

SPECIES GUAJUVERA
 LIGHT SENSITIVITY MEDIUM
 BP12100 1/2" x 5"

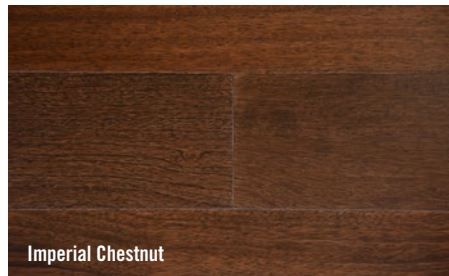

Imperial Chestnut

SPECIES JATOBA
 LIGHT SENSITIVITY MEDIUM
 BCH12222 1/2" x 5"

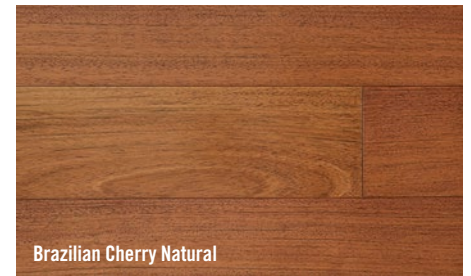

Brazilian Cherry Natural

SPECIES JATOBA
 LIGHT SENSITIVITY HIGH
 BC12100 1/2" x 5"

Product Gallery



Brazilian Walnut



Brazilian Pecan Natural



Imperial Chestnut



LARGO COLLECTION

5/8" ENGINEERED WIREBRUSHED WIDE PLANK HARDWOOD

Brazilian Oak South Beach

Our innovative "Largo" Collection achieves a fresh, clean, and modern aesthetic in a wide plank format most popular with today's designers and homeowners! The Brazilian Oaks in this collection make a magnificent impact with the ultra-clean and contemporary appearance, found exclusively in this unique species of Brazilian wood. Their linear grain patterns and wirebrushed texture add a lively touch to any living space. The Brazilian Chestnut products are featured well with the hand-stained process, while the wider format low gloss combination provide a much more modern feel to the timeless Tigerwood species!

DURABILITY (HARDNESS RATING)

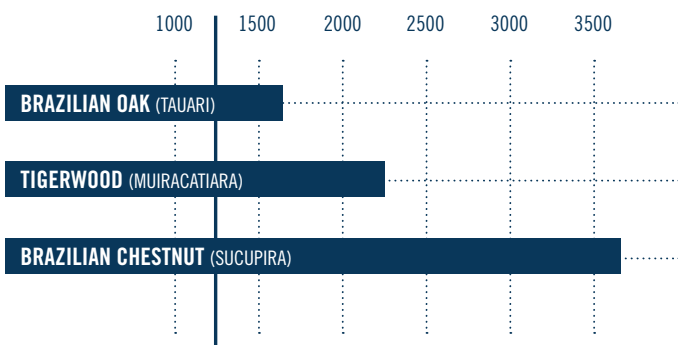

RED OAK 1290 RATING (Most Indusparquet species are harder than domestics.)

KEY FEATURES

- BRAZILIAN OAK, BRAZILIAN CHESTNUT, AND TIGERWOOD SPECIES
- SUBSTANTIAL 3.2MM SAWN FACE VENEERS
- THICK 5/8" ENGINEERED HARDWOOD
- 7 3/4" WIDE PLANK CONSTRUCTION
- LOW-GLOSS, WIREBRUSHED DECORS
- EXTRA LONG EXTRA WIDE BOARDS
- HARDER THAN DOMESTIC

PRODUCT INFORMATION

Thickness	5/8" ENGINEERED
Width	7 3/4"
Length	11" – 84"
Gloss Options	LOW
Installation	STAPLE, FLOAT, OR GLUE
Areas	ON, ABOVE, OR BELOW GRADE
Edge Profile	MICRO BEVEL
Packing	26.8 SF PER CARTON
Warranties	25 YEARS RESIDENTIAL AND 5 YEARS COMMERCIAL

Largo Collection

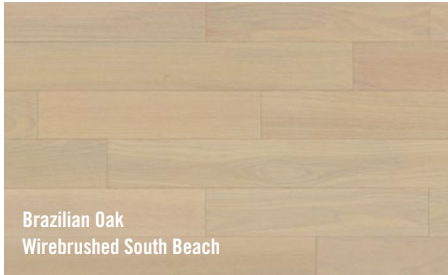

Brazilian Oak
Wirebrushed South Beach

SPECIES TAUARI
LIGHT SENSITIVITY MEDIUM
B058WB505 5/8" x 7 3/4"

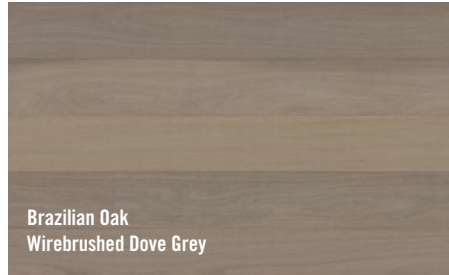

Brazilian Oak
Wirebrushed Dove Grey

SPECIES TAUARI
LIGHT SENSITIVITY LOW
B058WB508 5/8" x 7 3/4"

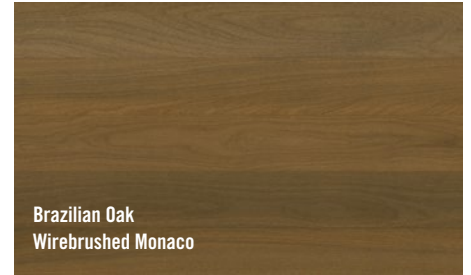

Brazilian Oak
Wirebrushed Monaco

SPECIES TAUARI
LIGHT SENSITIVITY LOW
B058WB509 5/8" x 7 3/4"

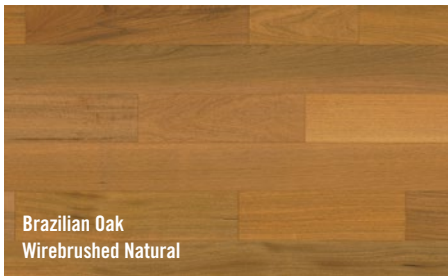

Brazilian Oak
Wirebrushed Natural

SPECIES TAUARI
LIGHT SENSITIVITY MEDIUM
B058WB100 5/8" x 7 3/4"

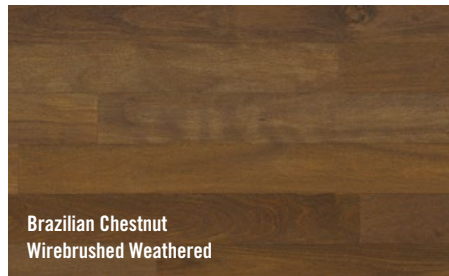

Brazilian Chestnut
Wirebrushed Weathered

SPECIES SUCUPIRA
LIGHT SENSITIVITY LOW
BCH58WB506 5/8" x 7 3/4"

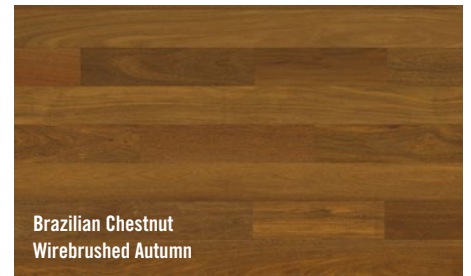

Brazilian Chestnut
Wirebrushed Autumn

SPECIES SUCUPIRA
LIGHT SENSITIVITY LOW
BCH58WB507 5/8" x 7 3/4"

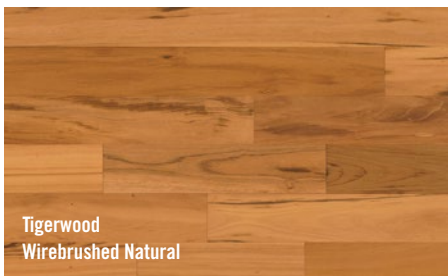

Tigerwood
Wirebrushed Natural

SPECIES MUIRACATIARA
LIGHT SENSITIVITY HIGH
TW58WB100 5/8" x 7 3/4"

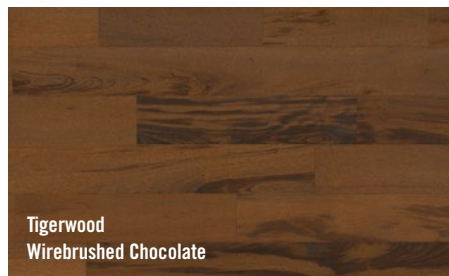

Tigerwood
Wirebrushed Chocolate

SPECIES MUIRACATIARA
LIGHT SENSITIVITY LOW
TW58WB501 5/8" x 7 3/4"

Product Gallery



Tigerwood Chocolate



Brazilian Oak Monaco



Brazilian Oak Dove Grey



NOVO COLLECTION

1/2" ENGINEERED WIREBRUSHED HARDWOOD

Brazilian Pecan Flint

The Indusparquet “Novo” Collection introduces a brilliant modern spin to traditional Brazilian Exotics! We are the only manufacturer to provide low-gloss, textured, and handscraped versions of these stunning wood species. The results are breathtaking! Our flat wirebrushed options offer a tremendously clean and contemporary look for any room. Our hardwood artisans produce a lightly handscraped and wirebrushed texture to the Langania series adding beauty you can actually touch and feel! Make a statement in your home with the Novo Collection!

DURABILITY (HARDNESS RATING)

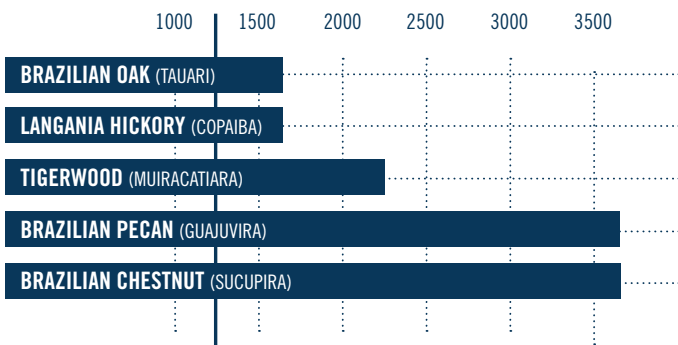

RED OAK 1290 RATING (Most Indusparquet species are harder than domestics.)

KEY FEATURES

- **5 BRAZILIAN SPECIES**
- **1/2" ENGINEERED HARDWOOD**
- **LOW GLOSS, WIREBRUSHED DECORS**
- **3MM DRY SAWN FACE VENEER** (EXCLUDING LANGANIA)
- **EXTRA LONG BOARD LENGTHS** (EXCLUDING BRAZ PECAN)
- **LANGANIA HICKORY SERIES - UNIQUE CHARACTERISTICS:**
 - LOW GLOSS, WIREBRUSHED, & HANDSCRAPED TEXTURE
 - HANDSCRAPED BY ARTISANS (NOT MACHINES)
 - 2MM ROTARY PEELED WIDE PLANK VENEER
 - EXTRA, EXTRA LONG BOARDS - UP TO 96"
 - DOUBLE STAINED PROCESS
 - SCULPTED ENDS AND EDGES

PRODUCT INFORMATION

Thickness	1/2" ENGINEERED
Width	5" & 7 1/2" (LANGANIA)
Length	11" - 84" (MOST); 11" - 48" (BRAZ PECAN); 11" - 96" (LANGANIA)
Gloss Options	LOW
Installation	STAPLE, FLOAT, OR GLUE
Areas	ON, ABOVE, OR BELOW GRADE
Edge Profile	MICRO BEVEL
Packing	5" - 30.03 SF PER CARTON 7-1/2" - 39.72 SF PER CARTON
Warranties	25 YEARS RESIDENTIAL AND 5 YEARS COMMERCIAL

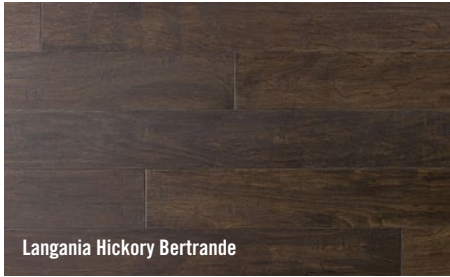

Langania Hickory Bertrande

SPECIES COPAIBA
 LIGHT SENSITIVITY LOW
 IPLHENGBE7 1/2" x 7 1/2"



Langania Hickory Affumicato

SPECIES COPAIBA
 LIGHT SENSITIVITY MEDIUM
 IPLHENGAF7 1/2" x 7 1/2"

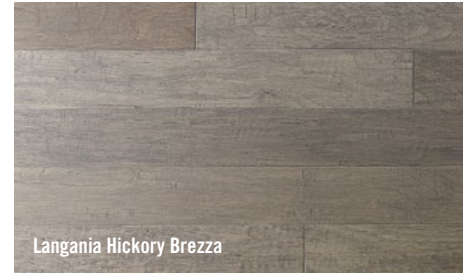

Langania Hickory Brezza

SPECIES COPAIBA
 LIGHT SENSITIVITY MEDIUM
 IPLHENGZ7 1/2" x 7 1/2"

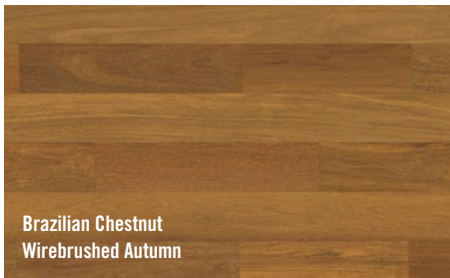

Brazilian Chestnut
Wirebrushed Autumn

SPECIES SUCUPIRA
 LIGHT SENSITIVITY LOW
 BCH12WB507 1/2" x 5"

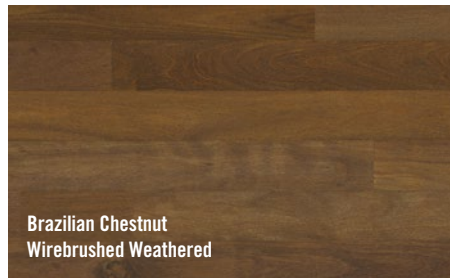

Brazilian Chestnut
Wirebrushed Weathered

SPECIES SUCUPIRA
 LIGHT SENSITIVITY LOW
 BCH12WB506 1/2" x 5"



Tigerwood
Wirebrushed Natural

SPECIES MUIRACATIARA
 LIGHT SENSITIVITY HIGH
 TW12WB100 1/2" x 5"

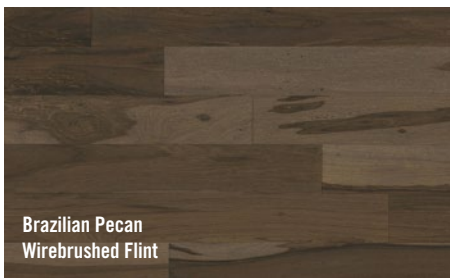

Brazilian Pecan
Wirebrushed Flint

SPECIES GUAJUUVIRA
 LIGHT SENSITIVITY HIGH
 BP12WB504 1/2" x 5"

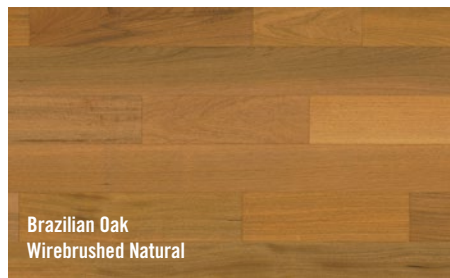

Brazilian Oak
Wirebrushed Natural

SPECIES TAUARI
 LIGHT SENSITIVITY MEDIUM
 TW12WB100 1/2" x 5"

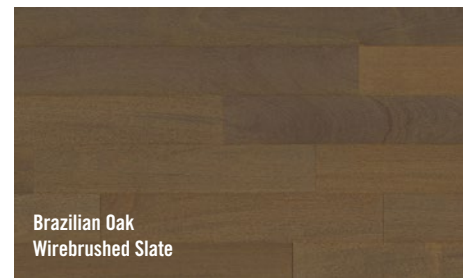

Brazilian Oak
Wirebrushed Slate

SPECIES TAUARI
 LIGHT SENSITIVITY LOW
 BO12WB503 1/2" x 5"

Product Gallery



Brazilian Chestnut Wirebrushed Autumn



Brazilian Oak Wirebrushed Slate



Langania Hickory Bertrande



VALOR COLLECTION

3/8" X 3 1/4" ENGINEERED HARDWOOD

Amendoim Natural

The “Valor” Collection by Indusparquet represents the best combination of beauty and value available in the most traditional Brazilian Hardwood products. The same standard of perfection goes into this line up...but in this trimmed down format we can offer the most savings for the consumer. It is important to note that the surface layer of this product is not compromised in the savings, as we still provide our signature 3MM Dry Sawn Face veneer to maintain the splendor and longevity expected from our brand. So, if you want the classic look of a smooth Brazilian species at a fraction of the price... the Valor Collection is for you!

DURABILITY (HARDNESS RATING)

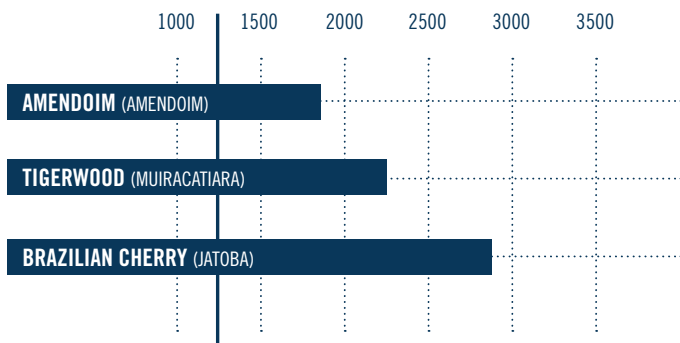

RED OAK 1290 RATING (Most Indusparquet species are harder than domestics.)

KEY FEATURES

- **INDUSPARQUET QUALITY AT ENTRY LEVEL PRICING**
- **3MM SAWN FACE VENEER**
- **ENGINEERED 3 1/4" WIDTHS**
- **CLASSIC AND AGELESS DESIGN**
- **HARDER THAN DOMESTIC**

PRODUCT INFORMATION

Thickness	3/8" ENGINEERED
Width	3 1/4"
Length	12" – 48"
Gloss Options	MEDIUM
Installation	STAPLE, FLOAT, OR GLUE
Areas	ON, ABOVE, OR BELOW GRADE
Edge Profile	MICRO BEVEL
Packing	19.5 SF PER CARTON 1248 SF PER PALLET
Warranties	25 YEARS RESIDENTIAL AND 5 YEARS COMMERCIAL

Valor Collection

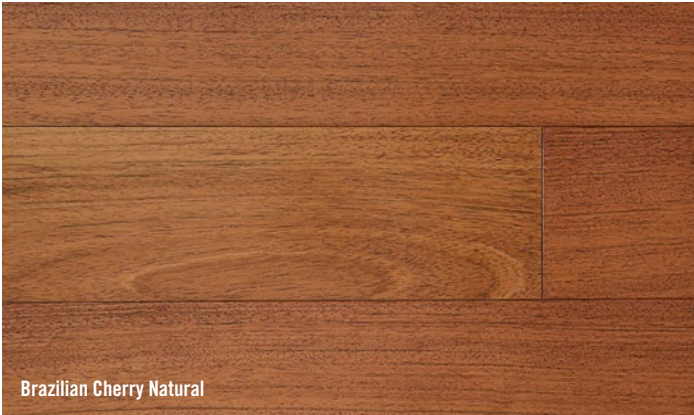

Brazilian Cherry Natural

SPECIES JATOBA
LIGHT SENSITIVITY HIGH
BC38100 3/8" x 3 1/4"



Amendoim

SPECIES AMENDOIM
LIGHT SENSITIVITY MEDIUM
AME38100 3/8" x 3 1/4"

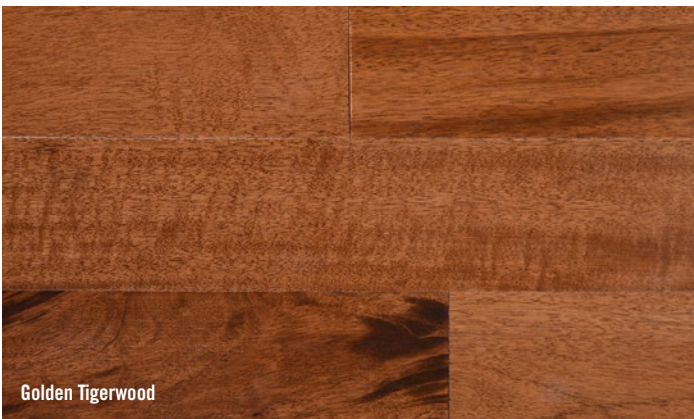

Golden Tigerwood

SPECIES MUIRACATIARA
LIGHT SENSITIVITY HIGH
TW38244 3/8" x 3 1/4"

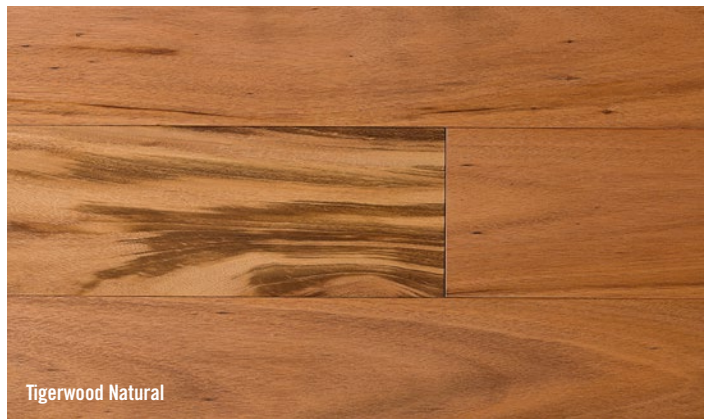

Tigerwood Natural

SPECIES MUIRACATIARA
LIGHT SENSITIVITY HIGH
TW38100 3/8" x 3 1/4"

Product Gallery

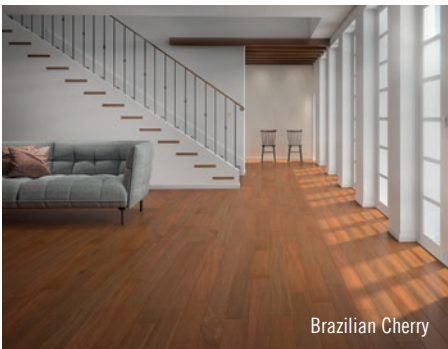

Brazilian Cherry



Tigerwood Natural



Golden Tigerwood



SOLIDO UNFINISHED COLLECTION

3/4" SOLID UNFINISHED HARDWOOD

Brazilian Chestnut

The "Solido Unfinished" Collection by Indusparquet offers customers an infinite number of custom design options in the highest quality Brazilian Hardwood produced. We manufacture this product with the exact same industry leading processes used to create our pre-finished product, just without the final stain and finish coat! Presented in boxes as opposed to bundles, our unfinished product is long in length and more dense and durable than most other hardwood flooring options. So, indulge yourself in creativity and customization of stains and onsite finish options using our Solido Unfinished Collection!

DURABILITY (HARDNESS RATING)

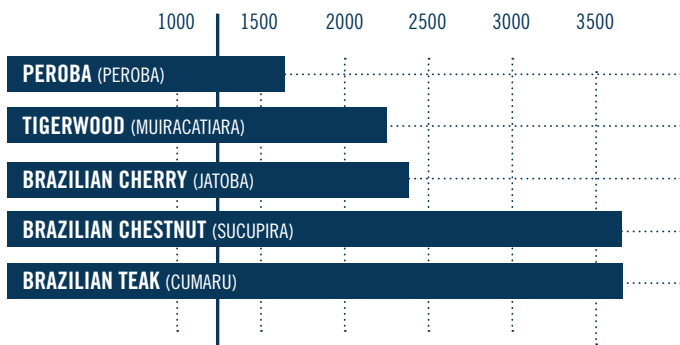

RED OAK 1290 RATING (Most Indusparquet species are harder than domestics.)

KEY FEATURES

- 5 BRAZILIAN SPECIES
- SOLID HARDWOOD
- VARIOUS WIDTHS AVAILABLE
- LONG BOARD LENGTHS
- PACKAGED IN BOXES, NOT BUNDLES
- HARDER THAN DOMESTIC

PRODUCT INFORMATION

Thickness	3/4" SOLID
Width	3", 4", 5 1/2"
Length	11" – 84"
Installation	NAIL ONLY
Areas	ON, ABOVE GRADE
Edge Profile	MICRO BEVEL
Grade	CLEAR PREMIUM
Packing	3" – 21.1SF PER CARTON 4" – 18.73 SF PER CARTON 5 1/2" - 19.37SF PER CARTON

Solido Unfinished Collection

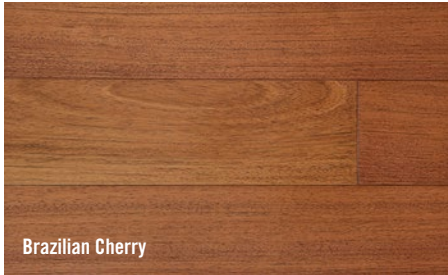

Brazilian Cherry

SPECIES JATOBÁ
 LIGHT SENSITIVITY HIGH
 BC343UF1000 3/4" x 3"
 BC344UF1000 3/4" x 4"
 BC345UF1000 3/4" x 5 1/2"



Tigerwood

SPECIES MUIRACATIARA
 LIGHT SENSITIVITY HIGH
 TW343UF1000 3/4" x 3"
 TW345UF1000 3/4" x 5 1/2"

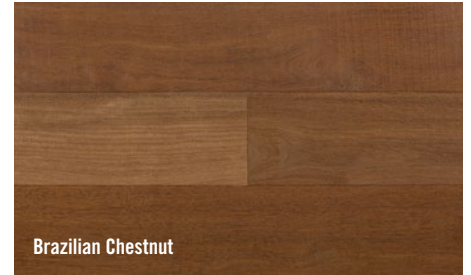

Brazilian Chestnut

SPECIES SUCUPIRA
 LIGHT SENSITIVITY LOW
 BCH343UF1000 3/4" x 3"
 BCH345UF1000 3/4" x 4"



Brazilian Teak

SPECIES CUMARU
 LIGHT SENSITIVITY LOW
 BT343UF1000 3/4" x 3"
 BT344UF1000 3/4" x 4"
 BT345UF1000 3/4" x 5 1/2"

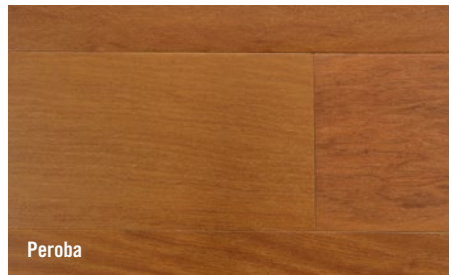

Peroba

SPECIES PEROBA
 LIGHT SENSITIVITY LOW
 PER344UF1000 3/4" x 4"

Product Gallery



Brazilian Cherry



Brazilian Teak



Tigerwood